

吉瑞普
Grip Pipe Tech

BEIJING GRIP PIPE
TECHNOLOGY
CO., LTD.



Grip Pipe Tech



Grip Pipe Tech

COMPANY PROFILE



吉瑞普
Grip Pipe Tech

Beijing Grip Pipe Technology Company Limited
is located in Beijing Development Area (BDA),

started pipe couplings and clamps R&D in late 1990s and started manufacturing in early 2000. Our patent, reliable and high quality pipe couplings and clamps were popular among military industries soon after they obtained the samples. Our products ideally solved their technical problems. Since then we Beijing Grip was acknowledged as an appointed pipe couplings supplier for marine equipment, shipbuilding, oil & gas in China for over decade. We continue developing and improving our products to meet customers increasingly demands.

Our products are certified with ISO9001-2008 ,CCS (China Classification Society), DNV, which confirm BJGRIP quality and make us the No.1 pipe couplings manufacturer in China. We obtain 2000 square meters manufacturing workshop, two R&D teams and one QC team to ensure timely and qualified production.

Along with the development and business growth, we just expanded oversea markets in year 2012. Our mission is to supply our excellent high quality and cost effective pipe couplings to users worldwide!

PRODUCTS OVERVIEW



GRIP-G
Axially Restrained With Double
Anchor Rings Coupling

Page.06



GRIP-GS
Customized narrow coupling.

Page.11



GRIP-D
Double Lock Pipe Clamp (Pipe
repair with a 2 lock active sealing
system coupling)

Page.15



GRIP-GF
Fireproof Coupling

Page.19



GRIP-RZ
Coupled pipe repair clamp

Page.23



GRIP-GTG
Axially restrained coupling for metal
and non-metal pipes connection

Page.25



GRIP-M
The multifunctional coupling---
connection and compensator in
one

Page.08



Grip-R
Repair Coupling

Page.13



Grip-Z
Reinforced Axially Restrained
Coupling

Page.17



GRIP-LM
Pull rod clamps

Page.21



GRIP-GT
Axially restrained coupling with
copper ring

Page.25



GRIP-RT
Double Lock Pipe Coupling with
Side Outlet

Page.25

COUPLINGS BENEFITS



Products Overview

GRIP pipe couplings offer you an easy way to install, a time saving and money saving solution. GRIP pipe couplings allow pipes to be joined without the need for flanging, grooving, threading or welding. By simply putting two pipes together and connecting with a GRIP pipe coupling, space, weight, time and cost savings are achieved with every installation.

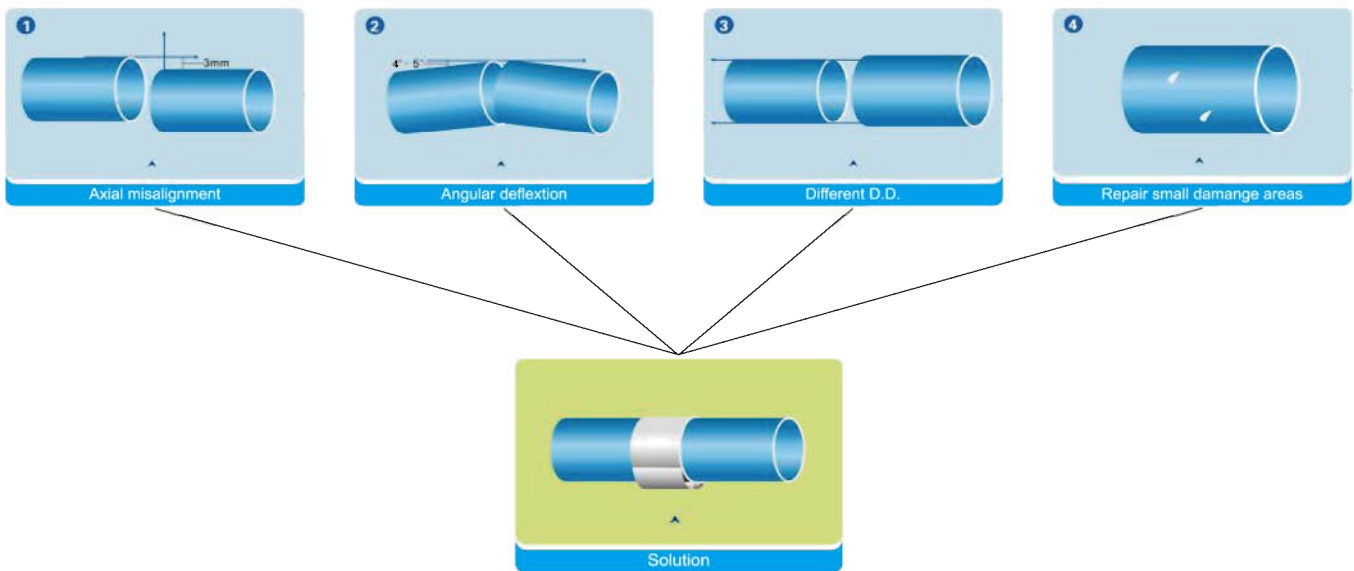

Progressive sealing effect

(Lip with pressure equalisation channel)
Increasing internal pressure increase the contact pressure of sealing lips

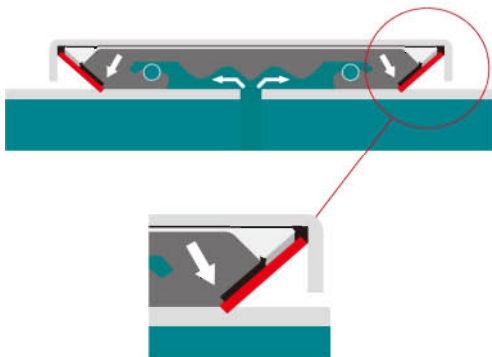

Progressive anchoring effect

Is easy on pipes, as pressure increase, so does the gripping effect

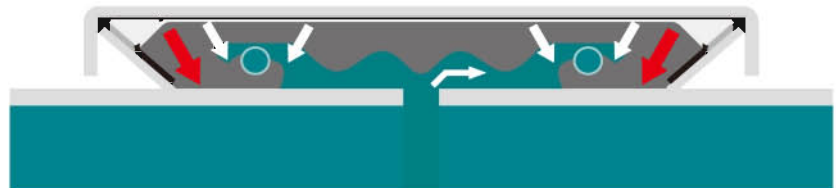

BENEFITS OF GRIP COUPLINGS

- Compatible with any traditional jointing system
- Joins pipes of the same or dissimilar materials
- Quick and simple repairs of damaged pipes without service interruptions
- Stress-free, flexible pipe joint
- Compensates axial movement and angular deflection
- Pressure-resistant and leak-proof even with inaccurate pipe assembly
- Detachable and reusable
- Maintenance free and trouble free
- No time-consuming alignment and fitting work
- Easy installation technology
- Progressive sealing effect
- Progressive anchoring effect
- Corrosion resistant and temperature resistant
- Good resistant to chemicals
- Long service time
- Compact design for space-saving installation of pipes
- Light weight
- Needs little space
- Easy installation, no fire or explosion hazard during installation
- No cost for protective measures
- Absorbs vibration /oscillations



GRIP Couplings are widely used in shipbuilding, commercial buildings and infrastructure.

Applications

- Oil pipelines
- Cooling water
- Compressed air
- Rinse water
- Waste water treatment
- Water distribution
- Gas distribution

Grip Pipe Tech

CERTIFICATES



PRODUCT TESTING

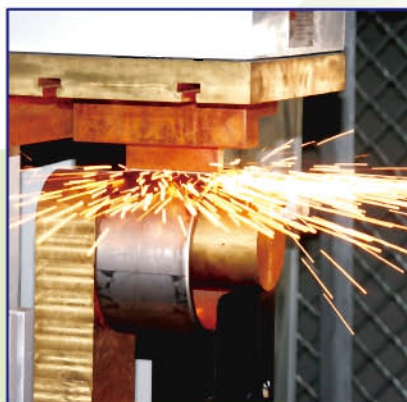
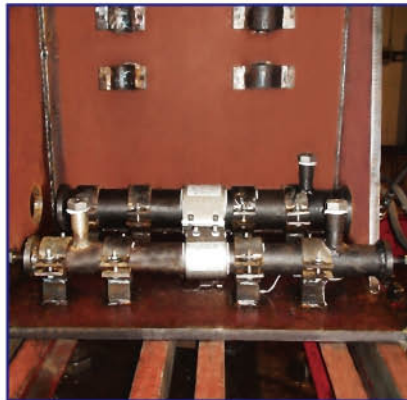
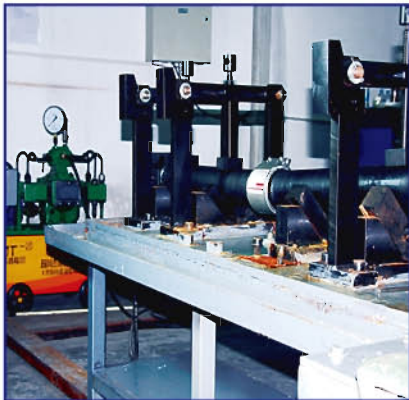
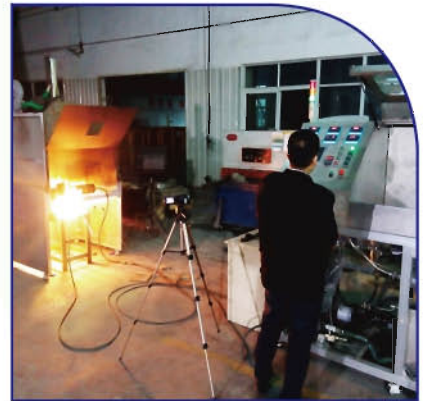
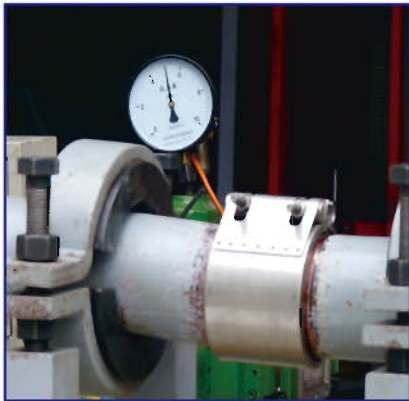

All Grip products are strictly tested before shipment of the factory to ensure reliable quality and the best performance of our products.

Grip Pipe Tech

PRODUCTS DETAILS

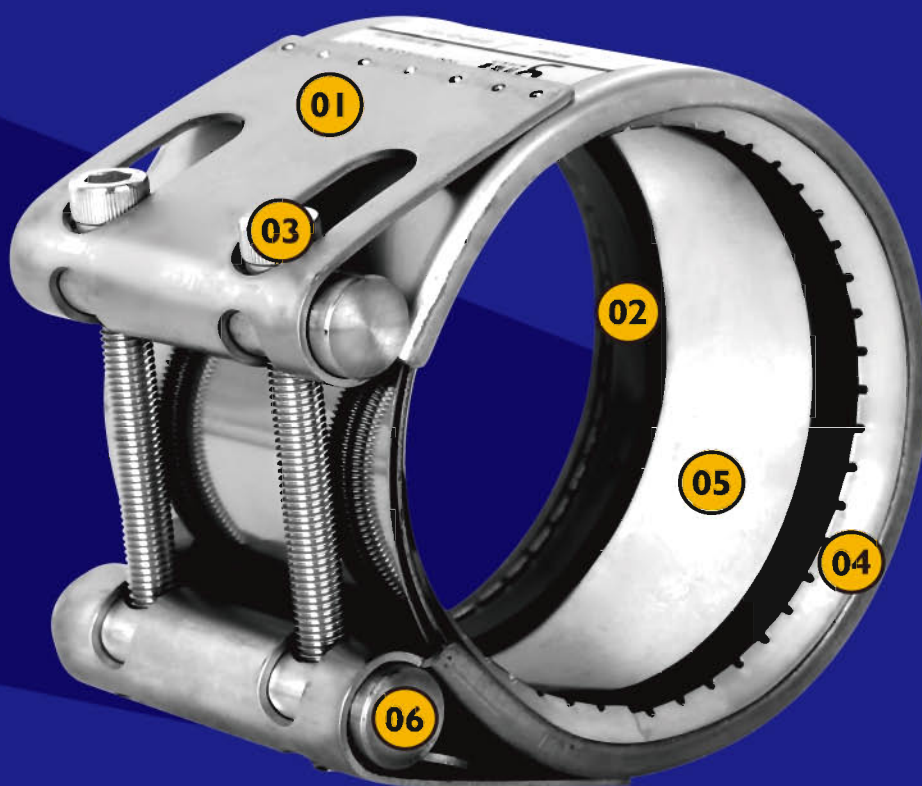

- 01 **Casing**
- 02 **Sealing sleeve**
- 03 **Bolt**
- 04 **Anchoring ring**
- 05 **Strip insert**
- 06 **Bar**

Components	Material	V1	V2	V3	V4	V5	V6
Casing		AISI 304	AISI 316L	AISI 316TI	AISI 316L	AISI 316TI	AISI 304
Bolts		AISI 304	AISI 316L	AISI 316L	AISI 304	AISI 304	AISI 4135
Bars		AISI 304	AISI 316L	AISI 316L	AISI 304	AISI 304	AISI 4135
Anchoring ring		AISI 301	AISI 301	AISI 301	AISI 301	AISI 301	AISI 301
Strip insert (optional)		AISI 301	AISI 301	AISI 301	AISI 301	AISI 301	AISI 301

Material of seal	Media	Temperature range
EPDM	All quality of waters, waste water, air, solids and chemical products	-30°C up to +120°C
NBR	Water, gas, oil, fuel and other hydrocarbons	-30°C up to +120°C
MVQ	High temperature liquid, oxygen, ozone, water and so on	-70°C up to +260°C
FPM/FKM	Ozone, oxygen, acids, gas, oil and fuel (only with strip insert)	-95°C up to +300°C

GRIP PRODUCTS

GRIP-G

Axially Restrained With Double Anchor Rings Coupling

The GRIP-G coupling is designed to replace the need for flanging, welding, pipe grooving and pipe threading by providing a quick and easy solution to joining plain-end pipe.

The GRIP-G has two anchor rings which are placed adjacent to, but separate from, the sealing mechanism.

Suitable for pipes O.D $\phi 26.9-\phi 273\text{mm}$



Outside view

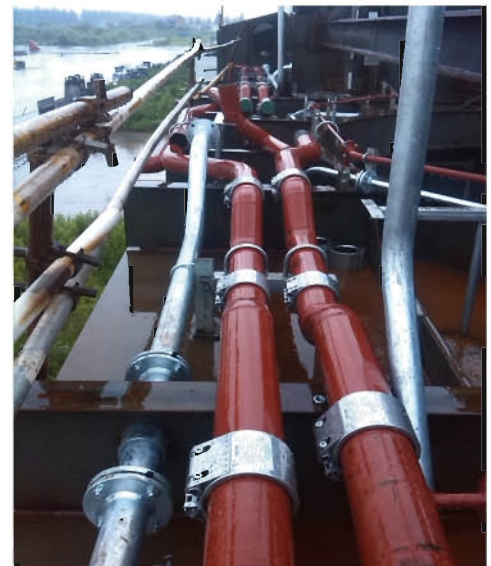
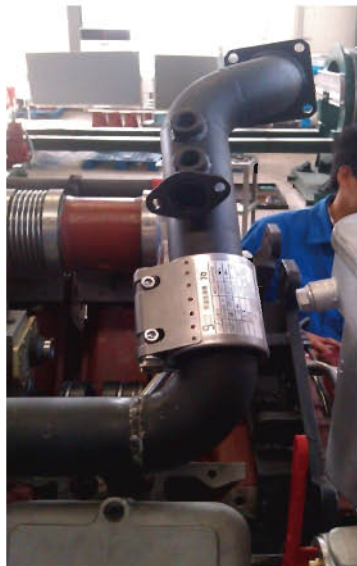
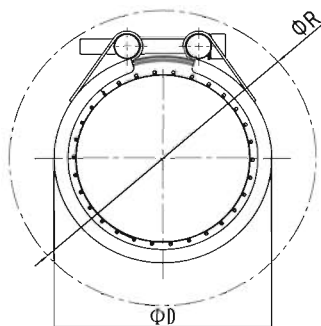
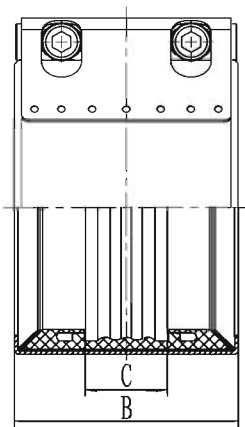

Material	V1	V2	V3	V4	V5	V6
Components						
Casing	AISI 304	AISI 316L	AISI 316TI	AISI 316L	AISI 316TI	
Bolts	AISI 304	AISI 316L	AISI 316L	AISI 304	AISI 304	
Bars	AISI 304	AISI 316L	AISI 316L	AISI 304	AISI 304	
Anchoring ring	AISI 301	AISI 301	AISI 301	AISI 301	AISI 301	
Strip insert (optional)	AISI 301	AISI 301	AISI 301	AISI 301	AISI 301	

Note:

1: Strip insert can be customized in AISI 316L/316TI

2: Please consult the BJ-GRIP technical department or its Agents when what you need is beyond the range of normal specification

GRIP PRODUCTS

GRIP-G

Pipe outside diameter		Clamping range	Working pressure		Product O.D.	Width	Distance between sealing slips	Setting gap between pipe ends		Torque rate	Bolt
O.D.		Min-Max			Φ D	B	C	without strip insert	with strip insert (Max)	(Nm)	M
(mm)	(in.)	(mm)	(bar)	(bar)	(mm)	(mm)	(mm)	(mm)	Max (mm)		
21.3	0.838	20-22	18	46	39	61	26	5-8	10	8	
26.9	1.059	26-28	18	46	43	61	26	5-8	10	8	
30	1.181	29-31	18	46	46	61	26	5-8	10	8	M6×2
33.7	1.327	32-35	18	40	50	61	26	5-8	10	8	
38	1.496	37-39	18	35	57	61	26	5-8	10	15	
42.4	1.669	41-43	18	32	61.3	61	26	5-8	10	15	
44.5	1.752	44-46	18	32	63.4	61	26	5-8	10	15	
48.3	1.902	47-49	18	32	67.2	61	26	5-8	10	15	M8×2
54	2.126	53-55	18	32	73	76	37	5-10	15	10	
57	2.244	56-58	18	32	76	76	37	5-10	15	10	
60.3	2.374	59-61	18	32	79.2	76	37	5-10	15	10	
66.6	2.622	64-68	18	32	88.7	95	37	5-10	25	20	
70	2.756	68-71	18	32	92	95	41	5-10	25	20	
73	2.874	72-74	18	32	95	95	41	5-10	25	20	
76.1	2.996	75-77	18	32	98.2	95	41	5-10	25	20	
79.5	3.130	78-81	18	32	101.6	95	41	5-10	25	20	
84	3.307	83-85	18	32	106	95	41	5-10	25	20	M8×2
88.9	3.500	87-91	18	32	111	95	41	5-10	25	20	
100.6	3.961	99-102	16	32	123	95	41	5-10	25	25	
101.6	4.000	100-103	16	32	123.7	95	41	5-10	25	25	
104	4.094	103-105	16	32	126	95	41	5-10	25	25	
108	4.252	106-109	16	32	130	95	41	5-10	25	25	
114.3	4.500	113-116	16	30	136.4	95	41	5-10	25	25	
127	5.000	126-128	16	25	151	110	54	5-10	35	40	
129	5.079	128-130	16	25	153	110	54	5-15	35	40	
130.2	5.126	129-132	16	25	154.3	110	54	5-15	35	40	
133	5.236	131-135	16	25	157	110	54	5-15	35	40	
139.7	5.500	138-142	16	25	163.8	110	54	5-15	35	40	M10×2
141.3	5.563	140-143	16	25	165.4	110	54	5-15	35	40	
154	6.063	153-156	16	25	176.4	110	54	5-15	35	40	
159	6.260	158-161	16	25	183	110	54	5-15	35	40	
168.3	6.626	167-170	16	22	189	110	54	5-15	35	40	
193.7	7.626	192-196	10	22	215	142	80	15-20	40	60	
200	7.874	198-202	10	22	222	142	80	15-20	40	60	
204	8.031	202-206	10	22	224	142	80	15-20	40	60	
206	8.110	204-208	10	22	234	142	80	15-20	40	60	
219.1	8.626	216-222	10	22	250	142	80	15-20	40	60	
244.5	9.626	242-247	10	20	275	142	80	15-20	40	60	M12X2
250	9.843	247-253	10	20	279	142	80	15-20	40	60	
254	10.000	251-257	10	20	282	142	80	15-20	40	60	
256	10.079	253-259	10	20	284	142	80	15-20	40	60	
267	10.512	264-270	10	20	297	142	80	15-20	40	60	
273	10.748	270-276	10	20	303	142	80	15-20	40	60	

Note:

Above table shows most common sizes, couplings can be customized for special outside diameters. Please contact us for further details.

 Working pressure for marine applications. Minimum burst is 4 times working pressure. Figures are based on typical values for standard wall carbon steel pipe.

 Working pressure for industrial and land-based applications. Minimum burst is 1.5 times working pressure.

Figures are based on typical values for standard wall carbon steel pipe.

Typing errors may occur, technical details are subject to change as improvements of products.

GRIP PRODUCTS

GRIP-M

The multifunctional coupling— connection and compensator in one

The Grip-M has two thick sealing lips which allow for pipe expansion and contraction. This type of coupling not only connects pipes, it simultaneously compensates the axial movement, giving a significant added value to the coupling.

Suitable for pipes O.D $\phi 26.9$ - $\phi 2032$ mm



Outside view

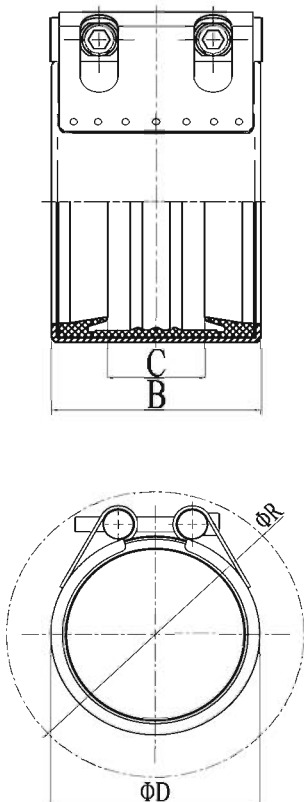

Material	V1	V2	V3	V4	V5	V6
Components						
Casing	AISI 304	AISI 316L	AISI 316TI	AISI 316L	AISI 316TI	
Bolts	AISI 304	AISI 316L	AISI 316L	AISI 304	AISI 304	
Bars	AISI 304	AISI 316L	AISI 316L	AISI 304	AISI 304	
Anchoring ring						
Strip insert (optional)	AISI 301	AISI 301	AISI 301	AISI 301	AISI 301	



Note:

1: Strip insert can be customized in AISI 316L/316TI

2: Please consult the BJ-GRIP technical department or its Agents when what you need is beyond the range of normal specification

GRIP PRODUCTS

GRIP-M

Pipe outside diameter		Clamping range	Working pressure		Product O.D.	Width	Distance between sealing slips	Setting gap between pipe ends		Torque rate	Bolt
O.D.		Min-Max			Φ D	B	C	without strip insert	with strip insert (Max)	(Nm)	M
(mm)	(in.)	(mm)	(bar)	(bar)	(mm)	(mm)	(mm)	(mm)	Max (mm)		
26.9	1.059	26-28	25	40	38.9	61	26	5-8	10	5	M6×2
30	1.181	29-31	25	40	42	61	26	5-8	10	5	
33.7	1.327	32-35	25	40	45.7	61	26	5-8	10	5	
38	1.496	37-39	25	40	52	61	26	5-8	10	7.5	
42.4	1.669	41-43	25	40	56.4	61	26	5-8	10	7.5	
44.5	1.752	44-46	25	40	58.5	61	26	5-8	10	7.5	
48.3	1.902	47-50	25	40	62.3	61	26	5-8	10	7.5	
54	2.126	52-56	20	35	70	76	37	5-10	15	10	M8×2
57	2.244	55-59	20	35	73	76	37	5-10	15	10	
60.3	2.374	59-62	20	35	76.3	76	37	5-10	15	10	
66.6	2.622	64-68	20	40	82.6	95	37	5-10	25	20	
70	2.756	68-71	20	40	86	95	41	5-10	25	20	
73	2.874	71-75	20	40	89	95	41	5-10	25	20	
76.1	2.996	74-78	20	40	92.1	95	41	5-10	25	20	
79.5	3.130	78-80	20	40	95.5	95	41	5-10	25	20	
84	3.307	82-86	20	40	100	95	41	5-10	25	20	
88.9	3.500	87-91	20	40	104.9	95	41	5-10	25	20	
100.6	3.961	99-103	18	35	118.6	95	41	5-10	25	20	
101.6	4.000	100-104	18	35	119.6	95	41	5-10	25	20	
104	4.094	102-106	18	35	122	95	41	5-10	25	20	
108	4.252	103-107	18	35	126	95	41	5-10	25	20	
114.3	4.500	113-116	18	35	132.3	95	41	5-10	25	20	
127	5.000	126-128	18	40	149	110	54	5-10	35	25	M10×2
129	5.079	128-130	18	40	151	110	54	5-10	35	25	
130.2	5.126	129-132	18	40	152.2	110	54	5-10	35	25	
133	5.236	131-135	18	40	155	110	54	5-10	35	25	
139.7	5.500	138-142	18	40	161.7	110	54	5-10	35	25	
141.3	5.563	140-143	18	40	163.3	110	54	5-10	35	25	
154	6.063	153-156	18	35	176	110	54	5-10	35	25	
159	6.260	158-161	18	35	181	110	54	5-10	35	25	
168.3	6.626	167-170	18	35	190.3	110	54	5-10	35	25	
180	7.087	166-171	16	30	202	142	75	10-25	40	50	M12×2
200	7.874	198-202	16	30	222	142	75	10-25	40	50	
219.1	8.626	216-222	16	30	249.1	142	75	10-25	40	60	
250	9.843	247-253	16	25	280	142	75	10-25	40	60	
267	10.512	264-270	16	25	297	142	75	10-25	40	60	
273	10.748	270-276	16	25	303	142	75	10-25	40	60	
304	11.969	301-307	10	20	334	142	75	10-25	40	80	
323.9	12.752	321-327	10	20	353.9	142	75	10-25	40	80	
355.6	14.000	353-358	8.5	16	385.6	142	75	10-25	40	80	
377	14.843	375-379	8.5	16	407.0	142	75	10-25	40	80	
406.4	16.000	404-409	7.5	16	436.0	142	75	10-25	40	80	
457.2	18.000	454-460	6.5	12	487.0	142	75	10-25	40	80	

Note:

Above table shows most common sizes, couplings can be customized for special outside diameters. Please contact us for further details.

 Working pressure for marine applications. Minimum burst is 4 times working pressure. Figures are based on typical values for standard wall carbon steel pipe.



 Working pressure for industrial and land-based applications. Minimum burst is 1.5 times working pressure.

Figures are based on typical values for standard wall carbon steel pipe.

Typing errors may occurs, technical details are subject to change as improvements of products.

GRIP PRODUCTS

GRIP-M

Pipe outside diameter		Clamping range	Working pressure		Product O.D.	Width	Distance between sealing slips	Setting gap between pipe ends		Torque rate	Bolt
O.D.	Min-Max			Φ D	B	C	without strip insert	with strip insert (Max)	(Nm)	M	
(mm)	(in.)	(mm)	(bar)	(mm)	(mm)	(mm)	(mm)	Max (mm)			
508	20.000	505-511	6	10	538.0	142	75	10-25	40	120	
558.8	22.000	556-562	5.5	10	588.8	142	75	10-25	40	160	
609.6	24.000	606-613	5	10	639.6	142	75	10-25	40	160	
711.2	28.000	708-715	4	5	741.2	142	75	10-25	40	160	
762	30.000	758-766	4	5	792.0	142	75	10-25	40	160	
812.8	32.000	809-817	4	5	842.8	142	75	10-25	40	200	
914.4	36.000	910-918	4	5	944.4	142	75	10-25	40	200	
1016	40.000	1012-1020	4	5	1046.0	142	75	10-25	40	200	
1117.6	44.000	1114-1122	3.5	5	1147.6	142	75	10-25	40	200	
1219.2	48.000	1215-1224	3.5	5	1249.2	142	75	10-25	40	200	M16x2
1320.8	52.000	1316-1325	3	5	1350.8	142	75	10-25	40	240	
1422.4	56.000	1418-1427	3	5	1452.4	142	75	10-25	40	240	
1524	60.000	1519-1529	2.5	5	1554	142	75	10-25	40	240	
1600	62.992	1595-1605	2.5	5	1630	142	75	10-25	40	240	
1625.6	64.000	1621-1631	2.5	5	1655.6	142	75	10-25	40	240	
1727.2	68.000	1722-1732	2.5	5	1757.2	142	75	10-25	40	240	
1828.8	72.000	1824-1834	2	5	1858.8	142	75	10-25	40	240	
1930.4	76.000	1925-1936	2	5	1960.4	142	75	10-25	40	240	
2032	80.000	2027-2037	2	5	2062	142	75	10-25	40	240	

Note:

Above table shows most common sizes, couplings can be customized for special outside diameters. Please contact us for further details.

 Working pressure for marine applications. Minimum burst is 4 times working pressure. Figures are based on typical values for standard wall carbon steel pipe.

 Working pressure for industrial and land-based applications. Minimum burst is 1.5 times working pressure.

Figures are based on typical values for standard wall carbon steel pipe.

Typing errors may occur, technical details are subject to change as improvements of products.



GRIP PRODUCTS

GRIP-GS

Customized narrow coupling.

Axial pull-out resistant.

Suitable for narrow space.

Suitable for pipes O.D. $\phi 76.1\text{mm}$ -
 $\phi 377\text{mm}$



Outside view

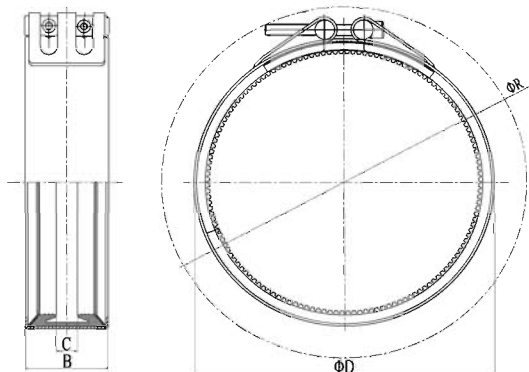

Material	Material					
	V1	V2	V3	V4	V5	V6
Components						
Casing	AISI 304	AISI 316L	AISI 316TI	AISI 316L	AISI 316TI	
Bolts	AISI 304	AISI 316L	AISI 316L	AISI 304	AISI 304	
Bars	AISI 304	AISI 316L	AISI 316L	AISI 304	AISI 304	
Anchoring ring	AISI 301	AISI 301	AISI 301	AISI 301	AISI 301	
Strip insert (optional)	AISI 301	AISI 301	AISI 301	AISI 301	AISI 301	

Note:

1: Strip insert can be customized in AISI 316L/316TI

2: Please consult the BJ-GRIP technical department or its Agents when what you need is beyond the range of normal specification

GRIP PRODUCTS

GRIP-GS

Pipe outside diameter		Clamping range	Working pressure		Width		Distance between sealing slips	Setting gap between pipe ends		Torque rate	Bolt
O.D.	Min-Max			B	C	without strip insert	with strip insert (Max)				
(mm)	(in.)	(mm)	(bar)	(bar)	(mm)	(mm)	(mm)	Max (mm)	(Nm)	M	
76.1	2.996	74-78	16	32	64	26	0-5	10	20		
79.5	3.130	78-80	16	32	64	26	0-5	10	20		
84	3.307	82-86	16	32	64	26	0-5	10	20		
88.9	3.500	87-91	16	32	64	26	0-5	10	20		
100.6	3.961	99-103	16	32	64	26	0-5	10	25		M8×2
101.6	4.000	100-104	16	32	64	26	0-5	10	25		
104	4.094	102-106	16	32	64	26	0-5	10	25		
108	4.252	103-107	16	32	64	26	0-5	10	25		
114.3	4.500	113-116	16	30	64	26	0-5	10	25		
127	5.000	126-128	8	25	64	26	0-5	10	30		
129	5.079	128-130	8	25	64	26	0-5	10	25		
130.2	5.126	129-132	8	20	64	26	0-5	10	25		
133	5.236	131-135	8	20	64	26	0-5	10	25		
139.7	5.500	138-142	8	20	64	26	0-5	10	25		
141.3	5.563	140-143	8	16	64	26	0-5	10	25		
154	6.063	153-156	8	16	64	26	0-5	10	25		
159	6.260	158-161	8	12	64	26	0-5	10	25		
168.3	6.626	167-170	8	12	64	26	0-5	10	30		
180	7.087	166-171	8	12	64	26	0-5	10	35		M8×2
200	7.874	198-202	8	12	64	26	0-5	10	40		
219.1	8.626	216-222	8	12	64	26	0-5	10	40		
250	9.843	247-253	8	12	64	26	0-5	10	45		
267	10.512	264-270	8	12	64	26	0-5	10	45		
273	10.748	270-276	8	12	64	26	0-5	10	45		
304	11.969	301-307	6	10	64	26	0-5	10	45		
323.9	12.752	321-327	6	10	64	26	0-5	10	45		
355.6	14.000	353-358	6	10	64	26	0-5	10	45		
377	14.843	375-379	6	10	64	26	0-5	10	45		

Note:

Above table shows most common sizes, couplings can be customized for special outside diameters. Please contact us for further details.

 Working pressure for marine applications. Minimum burst is 4 times working pressure. Figures are based on typical values for standard wall carbon steel pipe.

 Working pressure for industrial and land-based applications. Minimum burst is 1.5 times working pressure.

Figures are based on typical values for standard wall carbon steel pipe.

Typing errors may occur, technical details are subject to change as improvements of products.

GRIP PRODUCTS

GRIP-R

Repair Coupling

The Grip-R coupling is ideal for all situations where you need to make a permanent repair under pressure.

Simply open up the coupling, wrap it around the pipe and fasten- you have repaired the pipeline such as pipe joints, cracks etc in minutes and avoided the need for costly downtime.

Suitable for pipes O.D $\phi 26.9-\phi 168.3\text{mm}$



Outside view

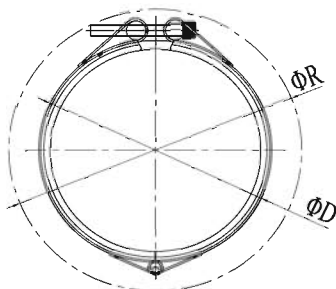
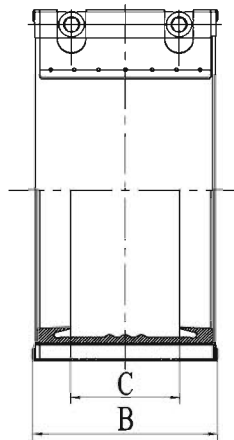

Material	V1	V2	V3	V4	V5	V6
Components						
Casing	AISI 304	AISI 316L	AISI 316TI	AISI 316L	AISI 316TI	
Bolts	AISI 304	AISI 316L	AISI 316L	AISI 304	AISI 304	
Bars	AISI 304	AISI 316L	AISI 316L	AISI 304	AISI 304	
Anchoring ring						
Strip insert (optional)	AISI 301	AISI 301	AISI 301	AISI 301	AISI 301	



Note:

1: Strip insert can be customized in AISI 316L/316TI

2: Please consult the BJ-GRIP technical department or its Agents when what you need is beyond the range of normal specification

GRIP PRODUCTS

GRIP-R

Pipe outside diameter		Clamping range	Working pressure		Product O.D.	Width	Distance between sealing slips	Setting gap between pipe ends		Torque rate	Bolt
O.D.	Min-Max			Φ D	B	C	without strip insert	with strip insert (Max)			
(mm)	(in.)	(mm)	(bar)	(mm)	(mm)	(mm)	(mm)	Max (mm)	(Nm)	M	
26.9	1.059	26-28	25	40	38	57	30	5-8	10	8	
30	1.181	29-31	25	40	42	57	30	5-8	10	8	M6×2
33.7	1.327	32-35	25	40	45	57	30	5-8	10	8	
38	1.496	37-39	25	40	50.3	61	26	5-8	10	10	
42.4	1.669	41-43	25	40	54.7	61	26	5-8	10	10	M8×1
44.5	1.752	44-46	25	40	56.8	61	26	5-8	10	10	
48.3	1.902	47-50	25	40	64.2	61	26	5-8	10	10	
54	2.126	52-56	20	35	70	76	37	5-10	15	10	
57	2.244	55-59	20	35	73	76	37	5-10	15	10	M8×2
60.3	2.374	59-62	20	35	76.2	76	37	5-10	15	10	
66.6	2.622	64-68	20	40	85.5	95	37	5-10	25	20	
70	2.756	68-71	20	40	89	95	41	5-10	25	20	
73	2.874	71-75	20	40	92	95	41	5-10	25	20	
76.1	2.996	74-78	20	40	95.2	95	41	5-10	25	20	
79.5	3.130	78-80	20	40	98.5	95	41	5-10	25	20	
84	3.307	82-86	20	40	103	95	41	5-10	25	20	
88.9	3.500	87-91	20	40	108	95	41	5-10	25	20	M8×2
100.6	3.961	99-103	18	35	120	95	41	5-10	25	20	
101.6	4.000	100-104	18	35	120.7	95	41	5-10	25	20	
104	4.094	102-106	18	35	123	95	41	5-10	25	20	
104.8	4.126	103-107	18	35	124	95	41	5-10	25	20	
108	4.252	106-110	18	35	127	95	41	5-10	25	20	
114.3	4.500	112-116	18	35	133.4	95	54	5-10	25	20	
127	5.000	125-129	18	40	148	110	54	5-10	35	25	
129	5.079	127-131	18	40	150	110	54	5-10	35	25	
130.2	5.126	128-132	18	40	151.3	110	54	5-10	35	25	
133	5.236	131-135	18	40	154	110	54	5-10	35	25	
139.7	5.500	138-142	18	40	160.8	110	54	5-10	35	25	M12×2
141.3	5.563	139-143	18	35	162.4	110	54	5-10	35	25	
154	6.063	152-156	18	35	173.4	110	54	5-10	35	25	
159	6.260	157-161	18	35	180	110	54	5-10	35	25	
168.3	6.626	166-171	18	35	186	110	54	5-10	35	25	

Note:

Above table shows most common sizes, couplings can be customized for special outside diameters. Please contact us for further details.

 Working pressure for marine applications. Minimum burst is 4 times working pressure. Figures are based on typical values for standard wall carbon steel pipe.

 Working pressure for industrial and land-based applications. Minimum burst is 1.5 times working pressure.

Figures are based on typical values for standard wall carbon steel pipe.

Typing errors may occur, technical details are subject to change as improvements of products.

GRIP PRODUCTS

GRIP-D

Double Lock Pipe Clamp (Pipe repair with a 2 lock active sealing system coupling)

The Grip-D can be fitted to existing pipes in situ, without any need to remove and relay the pipes.

This makes it the ideal solution for permanent repairs of pipe joints, cracks etc.

Suitable for pipes O.D $\varnothing 180\text{-}\varnothing 2032\text{mm}$



Outside view

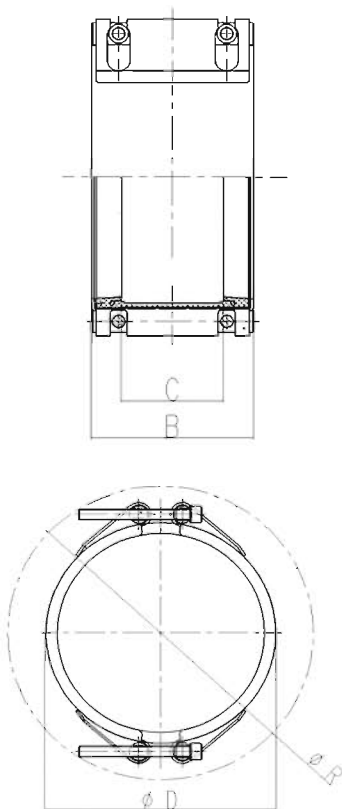

Material	V1	V2	V3	V4	V5	V6
Components						
Casing	AISI 304	AISI 316L		AISI 316L	AISI 316TI	AISI 304
Bolts	AISI 304	AISI 316L		AISI 304	AISI 304	AISI 4135
Bars	AISI 304	AISI 316L		AISI 304	AISI 304	AISI 4135
Anchoring ring						
Strip insert (optional)	AISI 301	AISI 301		AISI 301	AISI 301	AISI 301

Note:

1: Bars can be customized in AISI12 L 14 galvanised

2: Strip insert can be customized in AISI 316L/316TI

3: Please consult the BJ-GRIP technical department or its Agents what you need is beyond the range of normal specification

GRIP PRODUCTS

GRIP-D

Pipe outside diameter		Clamping range	Working pressure		Product O.D.	Width		Distance between sealing slips	Setting gap between pipe ends		Torque rate	Bolt
O.D.	Min-Max				Φ D	B	C	without strip insert	with strip insert (Max)			
(mm)	(In.)	(mm)	(bar)	(bar)	(mm)	(mm)	(mm)	(mm)	Max (mm)	(Nm)	M	
180	7.087	178-182	16	30	204	142	250	75	10-25	40	60	
200	7.874	198-202	16	30	224	142	250	75	10-25	40	60	
219.1	8.626	216-222	16	30	251.1	142	250	75	10-25	40	60	
250	9.843	247-253	16	25	282	142	250	75	10-25	40	80	
267	10.512	264-270	16	25	299	142	250	75	10-25	40	80	
273	10.748	270-276	16	25	305	142	250	75	10-25	40	80	
304	11.969	301-307	10	20	336	142	250	75	10-25	40	80	M12×2
323.9	12.752	320-327	10	20	355.9	142	250	75	10-25	40	80	
355.6	14.000	352-359	8.5	16	387.6	142	250	75	10-25	40	80	
377	14.843	375-379	8.5	16	409	142	250	75	10-25	40	80	
406.4	16.000	402-411	7.5	16	438	142	250	75	10-25	40	80	
457.2	18.000	452-462	6.5	12	489	142	250	75	10-25	40	80	
508	20.000	503-513	6	10	540	142	250	75	10-25	40	120	M16×2
558.8	22.000	554-564	5.5	10	590.8	142	250	75	10-25	40	160	
609.6	24.000	605-615	5	10	641.6	142	250	75	10-25	40	160	
711.2	28.000	708-715	4	5	743.2	142	250	75	10-25	40	160	
762	30.000	758-766	4	5	794	142	250	75	10-25	40	160	
812.8	32.000	809-817	4	5	844.8	142	250	75	10-25	40	160	
914.4	36.000	910-918	4	5	946.4	142	250	75	10-25	40	160	
1016	40.000	1012-1020	4	5	1048	142	250	75	10-25	40	200	
1117.6	44.000	1113-1122	3.5	5	1149.6	142	250	75	10-25	40	200	
1219.2	48.000	1215-1224	3.5	5	1251.2	142	250	75	10-25	40	200	M16×2
1320.8	52.000	1316-1325	3	5	1352.8	142	250	75	10-25	40	240	
1422.4	56.000	1418-1427	3	5	1454.4	142	250	75	10-25	40	240	
1524	60.000	1519-1529	2.5	5	1556	142	250	75	10-25	40	240	
1625.6	64.000	1621-1631	2.5	5	1657.6	142	250	75	10-25	40	240	
1727.2	68.000	1722-1732	2.5	5	1759.2	142	250	75	10-25	40	240	
1828.8	72.000	1824-1834	2	5	1860.8	142	250	75	10-25	40	240	
1930.4	76.000	1925-1935	2	5	1962.4	142	250	75	10-25	40	240	
2032	80.000	2027-2037	2	5	2064	142	250	75	10-25	40	240	

Note:

Above table shows most common sizes, couplings can be customized for special outside diameters. Please contact us for further details.

 Working pressure for marine applications. Minimum burst is 4 times working pressure. Figures are based on typical values for standard wall carbon steel pipe.

 Working pressure for industrial and land-based applications. Minimum burst is 1.5 times working pressure.

Figures are based on typical values for standard wall carbon steel pipe.

Typing errors may occur, technical details are subject to change as improvements of products.

GRIP PRODUCTS

GRIP-Z

Reinforced Axially Restrained Coupling

The GRIP-Z is a standard axial restrain coupling with reinforced internal structure so that can bear higher pressure.

The double anchoring rings can bite into the two pipes and prevent them from pulling apart.

Suitable for pipes O.D $\phi 30\text{-}\phi 168.3\text{mm}$

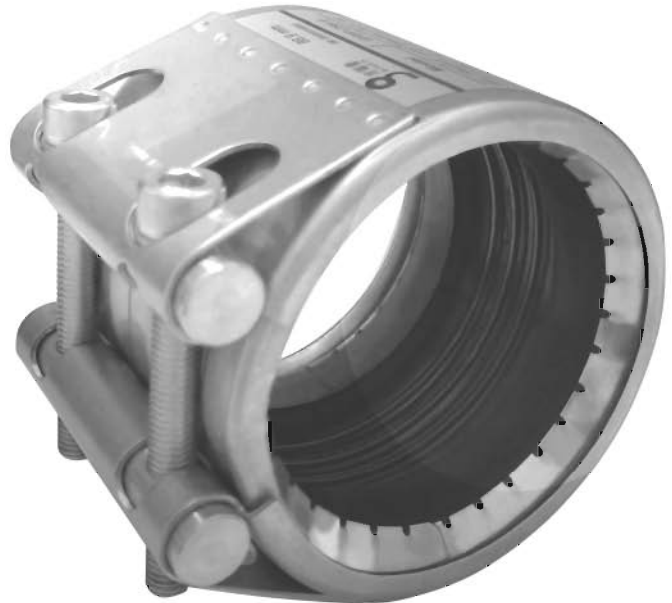

Outside view

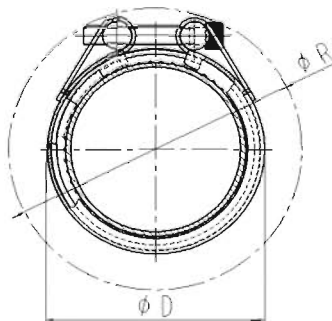
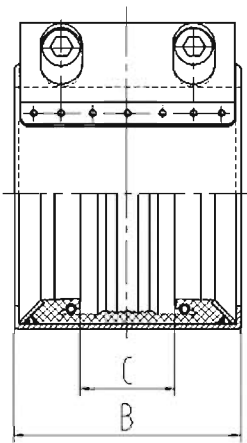

Material	V1	V2	V3	V4	V5	V6
Components						
Casing	AISI 304	AISI 316L	AISI 316TI			AISI 304
Bolts	AISI 316L	AISI 316L	AISI 316L			AISI 4135
Bars	AISI 316L	AISI 316L	AISI 316L			AISI 4135
Anchoring ring	AISI 301	AISI 301	AISI 301			AISI 301
Strip insert (optional)	AISI 301	AISI 301	AISI 301			AISI 301

Note:



1: Bars can be customized in AISI112 L 14 galvanised

2: Strip insert can be customized in AISI 316L/316TI

3: Please consult the BJ-GRIP technical department or its Agents when what you need is beyond the range of normal specification

GRIP PRODUCTS

GRIP-Z

Pipe outside diameter		Clamping range	Working pressure		Product O.D.	Width	Distance between sealing slips	Setting gap between pipe ends		Torque rate	Bolt
O.D.	Min-Max			Φ D	B	C	without strip insert	with strip insert (Max)	(Nm)	M	
(mm)	(In.)	(mm)	(bar)	(mm)	(mm)	(mm)	(mm)	Max (mm)			
30	1.181	29-31	32	64	47.5	61	17	3-5	10	10	M8×2
33.7	1.327	32-35	32	64	51.5	61	17	3-5	10	10	
38	1.496	37-39	32	64	58.5	61	17	3-5	10	20	M8×2
42.4	1.669	41-43	32	64	62.8	61	17	3-5	10	20	
44.5	1.752	44-45	32	64	64.9	61	17	3-5	10	20	
48.3	1.902	47-49	32	64	68.7	61	17	3-5	10	20	
54	2.126	53-55	30	64	74.5	76	33	5-10	15	25	M8×2
57	2.244	56-58	30	64	77.5	76	33	5-10	15	25	
60.3	2.374	59-61	30	64	80.7	76	33	5-10	15	25	M10×2
66.6	2.622	64-68	30	64	90.7	96	37	5-10	25	40	
70	2.756	68-71	25	64	94	96	37	5-10	25	40	
73	2.874	72-74	25	64	97	96	37	5-10	25	40	
76.1	2.996	75-77	25	64	100.2	96	37	5-10	25	40	
79.5	3.130	78-81	25	64	103.6	96	37	5-10	25	40	
84	3.307	83-85	25	64	108	96	37	5-10	25	40	
88.9	3.500	88-90	25	64	113	96	37	5-10	25	40	
100.6	3.961	99-102	22	60	125	96	37	5-10	25	40	M12×2
101.6	4.000	100-103	22	60	125.7	96	37	5-10	25	40	
104	4.094	103-105	22	60	128	96	37	5-10	25	40	
108	4.252	106-109	22	60	132	96	37	5-10	25	40	
114.3	4.500	113-116	22	50	138.4	96	37	5-10	25	40	
127	5.000	126-128	22	50	153.5	111	54	5-10	35	60	
129	5.079	128-130	22	50	155.5	111	54	5-10	35	60	
130.2	5.126	129-132	22	50	156.8	111	54	5-10	35	60	
133	5.236	131-135	22	50	159.5	111	54	5-10	35	60	M12×2
139.7	5.500	138-142	22	50	166.3	111	54	5-10	35	60	
141.3	5.563	140-143	22	50	167.9	111	54	5-10	35	60	
154	6.063	153-156	22	50	178.9	111	54	5-10	35	60	
159	6.260	158-161	22	50	185.5	111	54	5-10	35	60	
168.3	6.626	167-170	22	50	191.5	111	54	5-10	35	60	

Note:

Above table shows most common sizes, couplings can be customized for special outside diameters. Please contact us for further details.

 Working pressure for marine applications. Minimum burst is 4 times working pressure. Figures are based on typical values for standard wall carbon steel pipe.

 Working pressure for industrial and land-based applications. Minimum burst is 1.5 times working pressure.

Figures are based on typical values for standard wall carbon steel pipe.

Typing errors may occur, technical details are subject to change as improvements of products.

GRIP PRODUCTS

GRIP-GF

Fireproof Coupling

The Grip-GF combines with functional design with the latest technologies.

The GRIP-GF is based on the proven coupling technology, which has been developed for the shipbuilding industry, also is successfully used for tunneling, fire hose applications etc. In the event of a fire, GRIP-GF coupling protectively enclosing the coupling. During this process, the coupling retains its full operational capability without any damage.

Suitable for pipes O.D $\phi 26.9\text{-}\phi 273\text{mm}$

The GRIP-GF represents the ultimate in high security fire protected mechanical pipe couplings.



Outside view

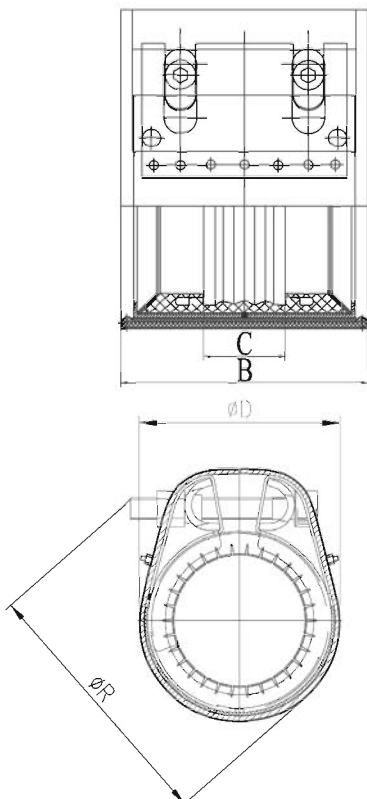

Material	V1	V2	V3	V4	V5	V6
Components						
Casing	AISI 304	AISI 316L	AISI 316TI	AISI 316L	AISI 316TI	
Bolts	AISI 304	AISI 316L	AISI 316L	AISI 304	AISI 304	
Bars	AISI 304	AISI 316L	AISI 316L	AISI 304	AISI 304	
Anchoring ring	AISI 301	AISI 301	AISI 301	AISI 301	AISI 301	
Strip insert (optional)	AISI 301	AISI 301	AISI 301	AISI 301	AISI 301	



Note:

1: Strip insert can be customized in AISI 316L/316TI

2: Please consult the BJ-GRIP technical department or its Agents when what you need is beyond the range of normal specification

GRIP PRODUCTS

GRIP-GF

Pipe outside diameter		Clamping range	Working pressure		Product O.D.	Width	Distance between sealing slips	Setting gap between pipe ends		Torque rate	Bolt
O.D.		Min-Max			Φ D	B	C	without strip insert	with strip insert (Max)		
(mm)	(In.)	(mm)	(bar)	(bar)	(mm)	(mm)	(mm)	(mm)	Max (mm)	(Nm)	M
21.3	0.84	20-23	18	46	52	56	19	5-8	10	8	
25	0.98	24-26	18	46	56	71	26	5-8	10	8	M6×2
26.9	1.059	26-28	18	46	58	71	26	5-8	10	8	
30	1.181	29-31	18	46	61	71	26	5-8	10	8	M6×2
33.7	1.327	32-35	18	40	65	71	26	5-8	10	8	
38	1.496	37-39	18	35	73	71	26	5-8	10	15	
42.4	1.669	41-43	18	32	77	71	26	5-8	10	15	
44.5	1.752	44-46	18	32	80	71	26	5-8	10	15	
48.3	1.902	47-49	18	32	83	71	26	5-8	10	15	M8×2
54	2.126	53-55	18	32	90	86	37	5-10	15	10	
57	2.244	56-58	18	32	93	86	37	5-10	15	10	
60.3	2.374	59-61	18	32	96	86	37	5-10	15	10	
66.6	2.622	64-68	18	32	105	105	37	5-10	25	20	
70	2.756	68-71	18	32	108	105	41	5-10	25	20	
73	2.874	72-74	18	32	111	105	41	5-10	25	20	
76.1	2.996	75-77	18	32	114	105	41	5-10	25	20	
79.5	3.130	78-81	18	32	118	105	41	5-10	25	20	
84	3.307	83-85	18	32	123	105	41	5-10	25	20	
88.9	3.500	87-91	18	32	127	105	41	5-10	25	20	M8×2
100.6	3.961	99-102	16	32	139	105	41	5-10	25	25	
101.6	4.000	100-103	16	32	140	105	41	5-10	25	25	
104	4.094	103-105	16	32	142	105	41	5-10	25	25	
108	4.252	106-109	16	32	146	105	41	5-10	25	25	
114.3	4.500	113-116	16	32	152	105	41	5-10	25	25	
127	5.000	126-128	16	30	171	120	54	5-10	35	40	
129	5.079	128-130	16	25	173	120	54	5-15	35	40	
130.2	5.126	129-132	16	25	174.3	120	54	5-15	35	40	
133	5.236	131-135	16	25	177	120	54	5-15	35	40	
139.7	5.500	138-142	16	25	183.8	120	54	5-15	35	40	M10×2
141.3	5.563	140-143	16	25	185.4	120	54	5-15	35	40	
154	6.063	153-156	16	25	198	120	54	5-15	35	40	
159	6.260	158-161	16	25	203	120	54	5-15	35	40	
168.3	6.626	167-170	16	25	212	120	54	5-15	35	40	
193.7	7.626	192-196	16	22	242	152	76	15-20	40	60	
200	7.874	198-202	10	22	249	152	76	15-20	40	60	
204	8.031	202-206	10	22	252	152	76	15-20	40	60	
206	8.110	204-208	10	22	255	152	76	15-20	40	60	
219.1	8.626	216-222	10	22	268	152	76	15-20	40	60	
244.5	9.626	242-247	10	22	294	152	76	15-20	40	60	M12×2
250	9.843	247-253	10	20	299	152	76	15-20	40	60	
254	10.000	251-257	10	20	303	152	76	15-20	40	60	
256	10.079	253-259	10	20	305	152	76	15-20	40	60	
267	10.512	264-270	10	20	316	152	76	15-20	40	60	
273	10.748	270-276	10	20	322	152	76	15-20	40	60	

Note:

Above table shows most common sizes, couplings can be customized for special outside diameters. Please contact us for further details.

 Working pressure for marine applications. Minimum burst is 4 times working pressure. Figures are based on typical values for standard wall carbon steel pipe.

 Working pressure for industrial and land-based applications. Minimum burst is 1.5 times working pressure.

Figures are based on typical values for standard wall carbon steel pipe.

GRIP PRODUCTS

GRIP-LM

Pull rod clamps

The GRIP-LM pipe coupling including three pull rods which can effectively reduce the axial pull strength of pipes.

The perfect combination of pull rods and coupling greatly lessen vibration, lower noise as well as provide ideal compensation. Easy and quick installation make GRIP-LM a reliable choice for you.

Suitable for pipes O.D $\phi 304\text{-}\phi 762\text{mm}$

GRIP-LM only can be used on metal pipes.



Outside view

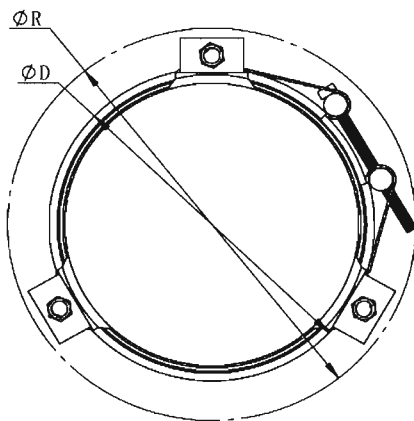
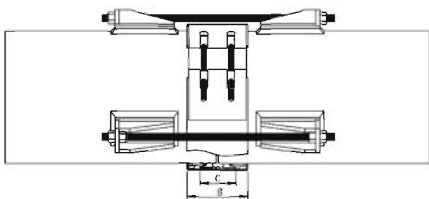

Material	V1	V2	V3	V4	V5	V6
Components						
Casing	AISI 304	AISI 316L	AISI 316TI	AISI 316L	AISI 316TI	AISI 304
Bolts	AISI 304	AISI 316L	AISI 316L	AISI 304	AISI 304	AISI 4135
Bars	AISI 304	AISI 316L	AISI 316L	AISI 304	AISI 304	AISI 4135
Anchoring ring						
Strip insert (optional)	AISI 301	AISI 301	AISI 301	AISI 301	AISI 301	

Note:



1: Bars can be customized in AISI12 L 14 galvanised

2: Strip insert can be customized in AISI 316L/316TI

3: Please consult the BJ-GRIP technical department or its Agents when what you need is beyond the range of normal specification

GRIP PRODUCTS

GRIP-LM

Pipe outside diameter		Clamping range	Working pressure		Product O.D.	Width	Distance between sealing slips	Setting gap between pipe ends		Torque rate	Bolt
O.D.	Min-Max			Φ D	B	C	without strip insert	with strip insert (Max)			
(mm)	(In.)	(mm)	(bar)	(bar)	(mm)	(mm)	(mm)	(mm)	Max (mm)	(Nm)	M
180	7.087	176-183	16	30	202	142	75	10-25	40	50	M12×2
200	7.874	198-202	16	30	222	142	75	10-25	40	50	
219.1	8.626	216-222	16	30	249.1	142	75	10-25	40	60	
250	9.843	247-253	16	25	280	142	75	10-25	40	60	
267	10.512	264-270	16	25	297	142	75	10-25	40	60	
273	10.748	270-276	16	25	303	142	75	10-25	40	60	
304	11.969	301-307	10	20	334	142	75	10-25	40	80	M12×2
323.9	12.752	320-327	10	20	353	142	75	10-25	40	80	
355.6	14.000	352-359	8.5	16	385.6	142	75	10-25	40	80	
377	14.843	375-379	8.5	16	407	142	75	10-25	40	80	
406.4	16.000	402-411	7.5	16	436	142	75	10-25	40	80	
457.2	18.000	452-462	6.5	16	487	142	75	10-25	40	80	
508	20.000	503-513	6	12	538	142	75	10-25	40	120	M12×2
558.8	22.000	554-564	5.5	10	588.8	142	75	10-25	40	160	
609.6	24.000	605-615	5	10	639.6	142	75	10-25	40	160	
711.2	28.000	708-715	4	5	741.2	142	75	10-25	40	160	
762	30.000	758-766	4	5	792	142	75	10-25	40	160	

Note:

Above table shows most common sizes, couplings can be customized for special outside diameters. Please contact us for further details.

 Working pressure for marine applications. Minimum burst is 4 times working pressure. Figures are based on typical values for standard wall carbon steel pipe.

 Working pressure for industrial and land-based applications. Minimum burst is 1.5 times working pressure.

Figures are based on typical values for standard wall carbon steel pipe.

Typing errors may occurs, technical details are subject to change as improvements of products.

GRIP PRODUCTS

GRIP-RZ

Coupled pipe repair clamp

The GRIP-RZ Coupled pipe repair clamp can safely and reliably seal damaged pipes such as corrosion, mesh holes, cracks or leakages without pipe changing. New designed unitary sealing sleeve ensures complete sealing effect. Easy and quick installation completed by wrapping the clamp to target position, tightening all the bolt.

Strong pressure bearing ability up to 8MPa, can be widely used in oil pipeline, chemistry industry, grid, mining field, gas pipeline. Suitable for pipes O.D $\phi 26.9\text{-}\phi 812.8\text{mm}$
Progressive sealing effect

If the pressure in the pipes rises, the contact pressure on the sealing lips also increase due to the flow through the pressure equalization channel.

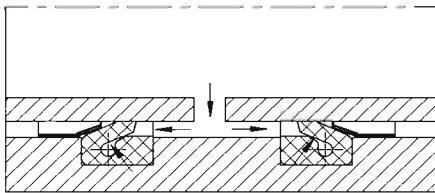

Outside view

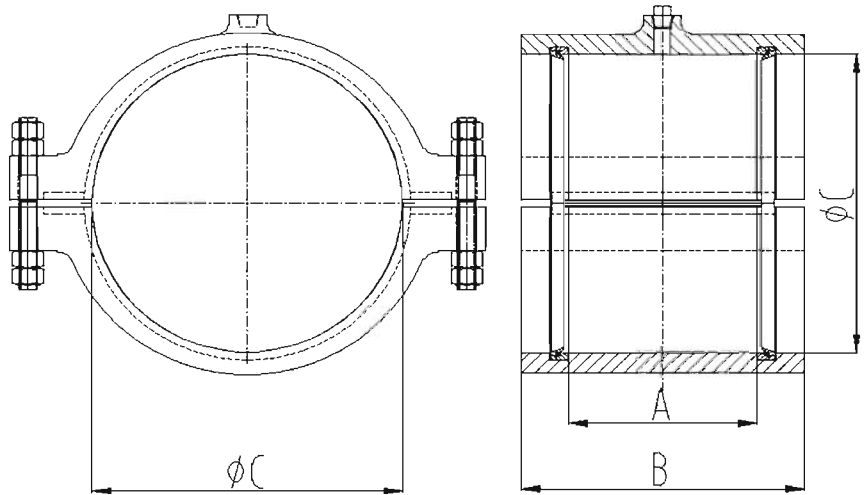



Components	Material
Casing	ZG270-500/ZG35
Bolts	Class12.9
Sealing	EPDM/NBR

Note:

1: Please consult the BJ-GRIP technical department or its Agents when what you need is beyond the range of normal specification

GRIP PRODUCTS

GRIP-RZ

Pipe outside diameter		Clamping range	Working pressure	
O.D.		Min-Max		
(mm)	(in.)	(mm)	(bar)	(psi)
26.9	1.059	26-28	120	1740
30	1.181	29-31	120	1740
33.7	1.327	32-35	120	1740
38	1.496	37-39	120	1740
42.4	1.669	41-43	120	1740
44.5	1.752	44-45	120	1740
48.3	1.902	47-49	120	1740
54	2.126	53-55	120	1740
57	2.244	56-58	120	1740
60.3	2.374	59-61	120	1740
66.6	2.622	64-68	120	1740
70	2.756	68-71	120	1740
73	2.874	72-74	120	1740
76.1	2.996	75-77	120	1740
79.5	3.130	78-81	120	1740
84	3.307	83-85	120	1740
88.9	3.500	88-90	120	1740
100.6	3.961	99-102	100	1450
101.6	4.000	100-103	100	1450
104	4.094	103-105	100	1450
108	4.252	106-109	100	1450
114.3	4.500	113-116	100	1450
127	5.000	126-128	100	1450
129	5.079	128-130	100	1450
130.2	5.126	129-132	100	1450
133	5.236	131-135	100	1450
139.7	5.500	138-142	100	1450
141.3	5.563	140-143	100	1450
154	6.063	153-156	100	1450
159	6.260	158-161	100	1450
168.3	6.626	167-170	100	1450
180	7.087	178.0-182.0	100	1450
193.7	7.626	192.0-196.0	100	1450
200	7.874	198.0-202.0	80	1160
204	8.031	202.0-206.0	80	1160
206	8.110	204.0-208.0	80	1160
219.1	8.626	216.0-222.0	80	1160
244.5	9.626	242.0-247.0	80	1160
250	9.843	247.0-253.0	80	1160
254	10.000	251.0-257.0	80	1160
256	10.079	253.0-259.0	80	1160
267	10.512	264.0-270.0	80	1160
273	10.748	270.0-276.0	80	1160
304	11.969	301.0-307.0	60	870
306	12.047	303.0-309.0	60	870
323.9	12.752	320.0-327.0	60	870
355.6	14.000	352.0-359.0	60	870
406.4	16.000	402.0-411.0	60	870
457.2	18.000	452.0-462.0	60	870
508	20.000	503.0-513.0	60	870
558.8	22.000	554.0-564.0	60	870
609.6	24.000	605.0-615.0	60	870
660.4	26.000	655.0-665.0	60	870
711.2	28.000	703.0-716.0	60	870
762	30.000	757.0-767.0	60	870
812.8	32.000	808.0-818.0	60	870

GRIP PRODUCTS

GRIP-GT

Axially restrained coupling with copper ring

The GRIP-GT is ideal for various non-metal pipes axially restrained connection.

Unique threaded copper anchoring ring design enable the coupling connect the pipes properly without slight scratch or damage. The coupling connects the pipe evenly.

Suitable for pipes O.D $\phi 26.9-\phi 800.0$ mm



GRIP PRODUCTS

GRIP-GTG

Axially restrained coupling for metal and non-metal pipes connection

The GRIP-GTG is a perfect solution for pipes with different materials typically as metal and non-metal ones.

Suitable for pipes O.D $\phi 26.9-\phi 800.0$ mm



GRIP PRODUCTS

GRIP-RT

Double Lock Pipe Coupling with Side Outlet

The GRIP-RT combines all the advantages of GRIP coupling technologies, with the added benefit of a side outlet.

A simple, low-cost solution for a wide range of applications, including venting, sample-taking, measurement points and system extensions. Suitable for pipes O.D $\phi 26.9-\phi 2032$ mm

GRIP-RT can be customized according customers requests.

Applicable for below models:

GRIP-G, GRIP-M, GRIP-R, GRIP-D, GRIP-Z, GRIP-GT, GRIP-GTG



INSTALLATION STEPS & ACCESSORY

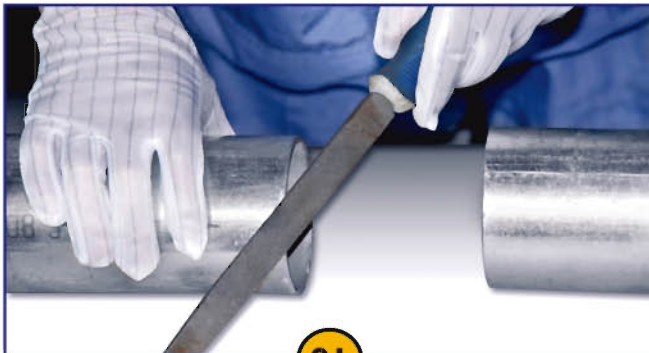

01

Step 1: Deburr and remove the ash, dust and sundry, Keep the two pipe ends cut surface smooth.



02

Step 2: Find the assembly line, and mark the location of the insert connector.



03

Step 3: Put the coupling on and keep it in mark position.



04

Step 4: put the other pipe in the coupling and ensure the coupling in mark position.



05

Step 5: Tightening the two bolts alternately with specified torque wrench



06

Step 6: Finished

INSTALLATION GUIDE

Handling of GRIP couplings

- Do not drop the coupling
- Keep the coupling clean- leave it in its packaging until you are ready to use it
- Do not dismantle the coupling
- Check the coupling for completeness: check the anchor rings are present on both sides if you are using axially resistant couplings and if you have requested a vacuum ring, please check that it is in place

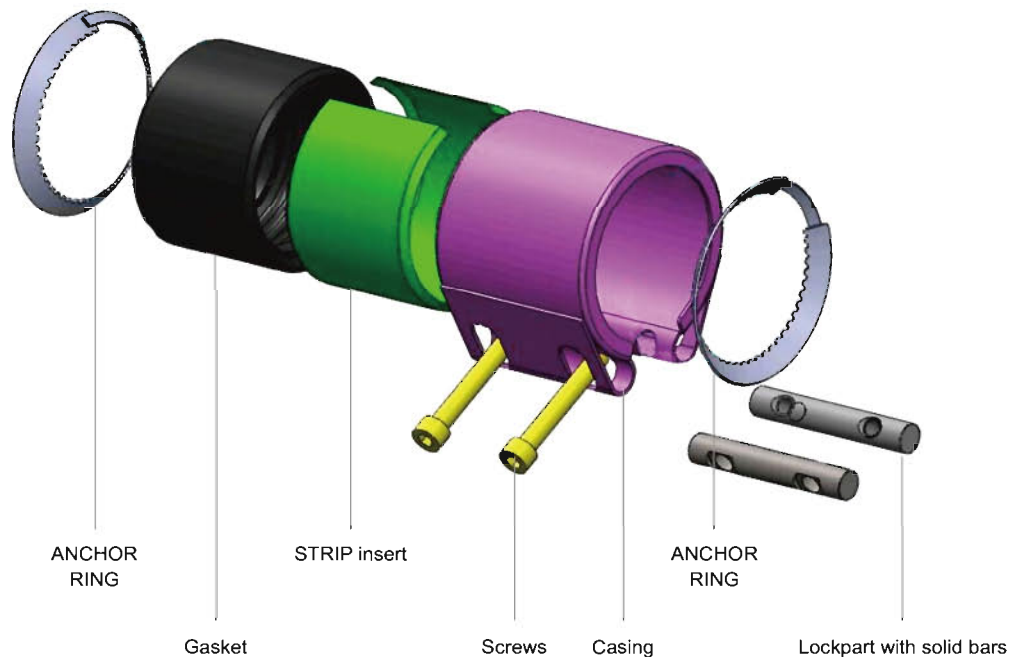

Installation tool: Torque Wrench

To ensure successful use, a torque wrench must be used when install. Please select proper wrench for each types as indicated on the label.

The coupling do not require any maintenance and must not be tightened once the torque has been reached. We recommend you mark the coupling once the screws have been torqued up. This will ensure that you and others know that the screws have been tightened.

If you are unsure as to whether the screws have already been tightened, loosen the screws completely and repeat the installation from scratch.



PIPELINE COMPENSATORS

Flexible compenators



GRIP-FR1
Flexible Rubber Joint



GRIP-FR2
Flexible Rubber Joint



GRIP-CEC
SS Corrugated Expansion Compensator



GRIP-DC
SS Dismantling connector



GRIP-SC
Spherical Compensator



GRIP-FA
SS Flexible Adapter

Band Repair Clamp



GRIP-S1 Band Repair Clamp



GRIP-S2 SS Band Repair Clamp



GRIP-S Economic Coupling

Beijing Grip Pipe Technology Co., Ltd.

 12#, Xinghai 1st Str, Boxing 8th Rd, BDA, Beijing, China.

 +86-10-87398035

 +86-10-87398232

 bjgrip@bjgrip.com

 www.bjgripcouplings.com



吉瑞普
Grip Pipe Tech